

kuku ↓

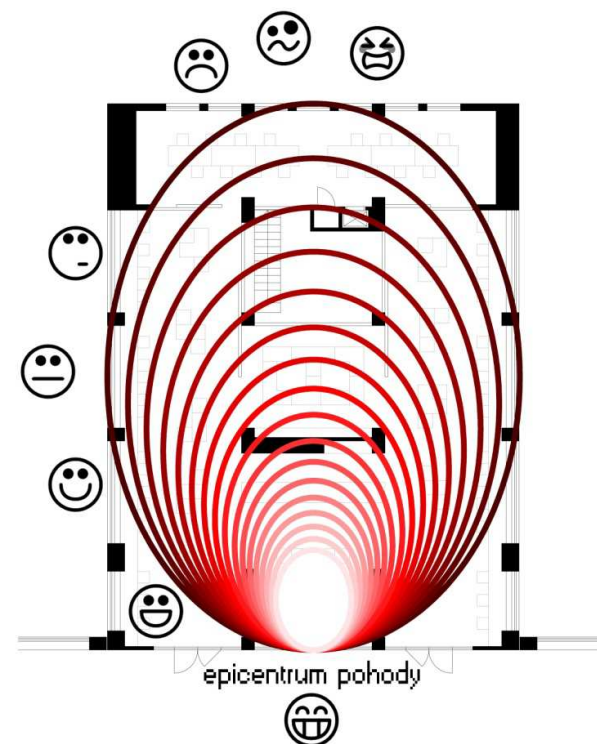

dělení prostoru
,vlny pohody' šířící se z centra pohody – kavárny
v závislosti na vlnách a oblastech navržen nábytek

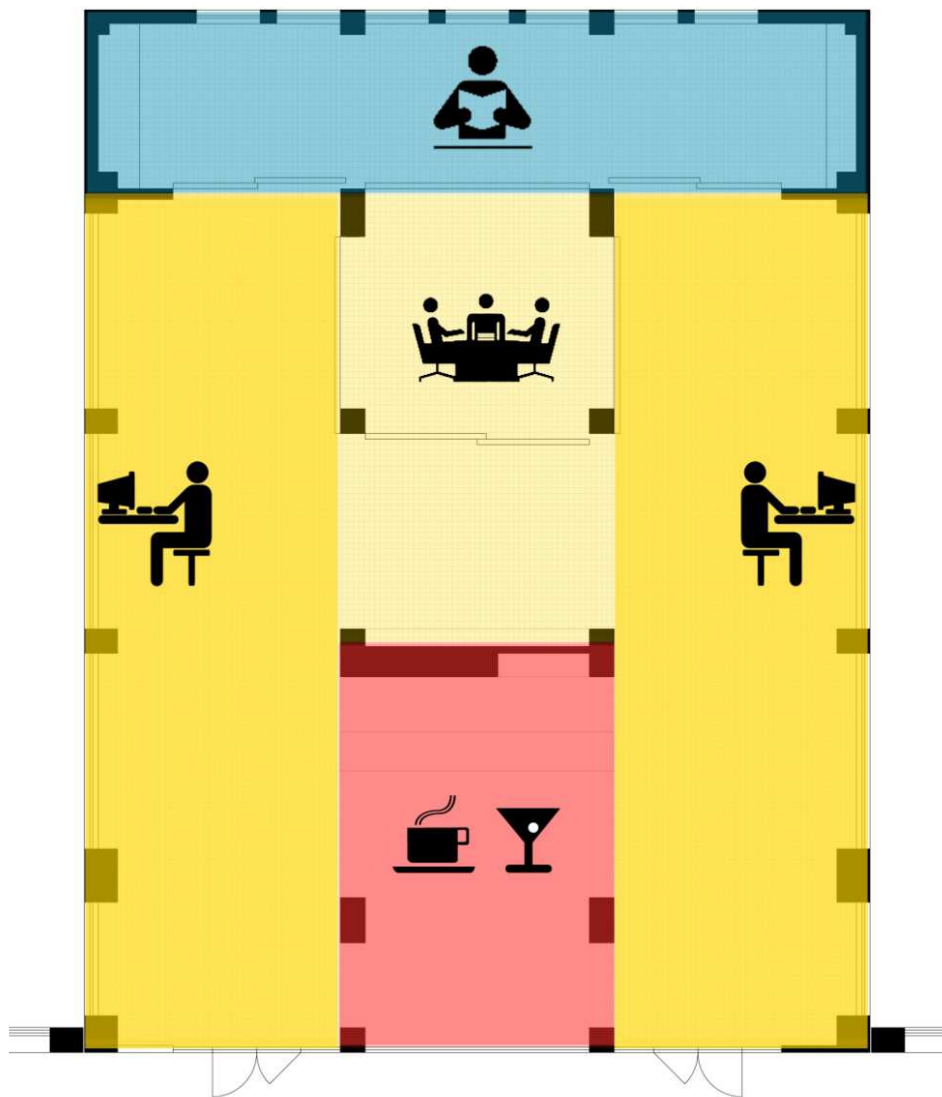
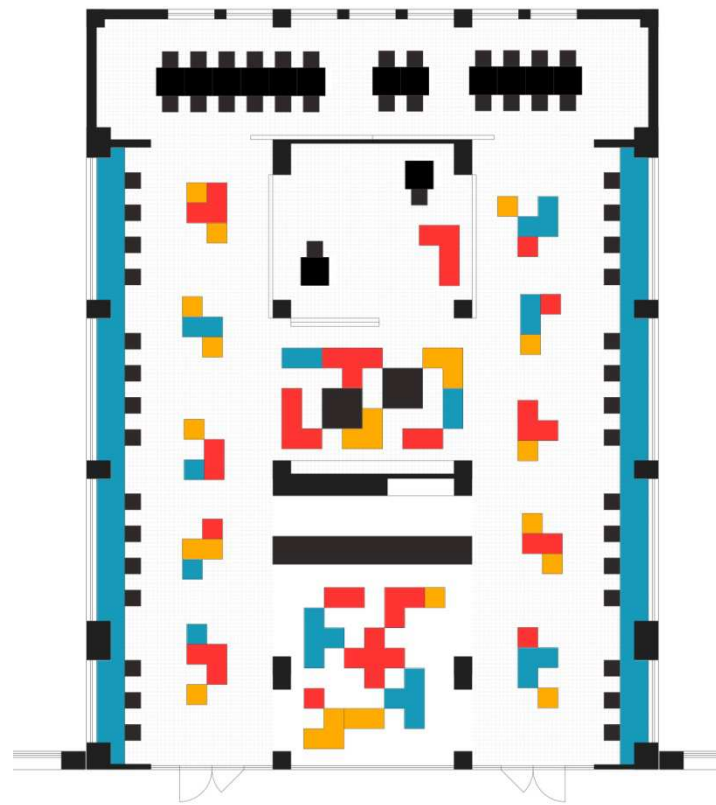
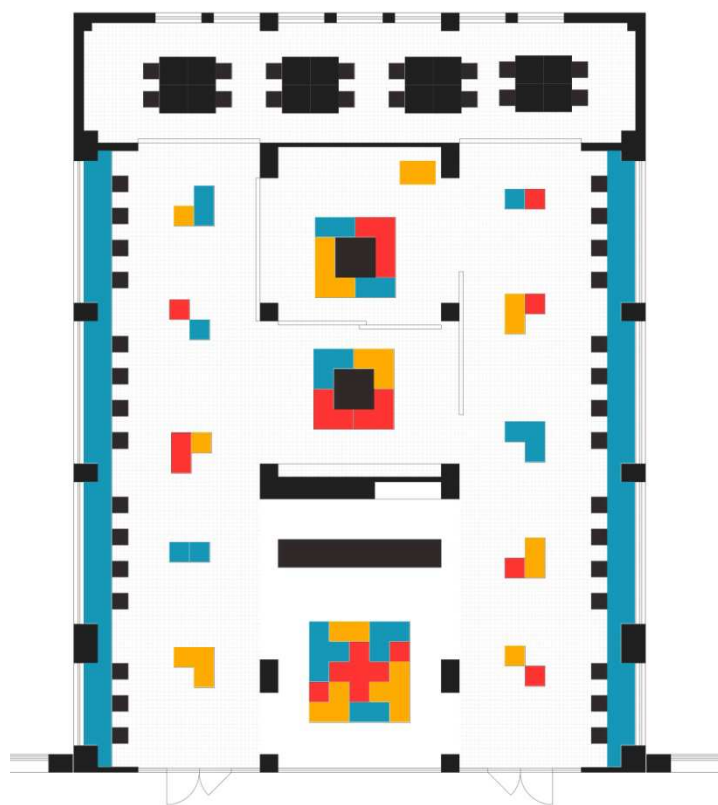

půdorysy_kavárna/studovna
zadní tichá studovna_možnosti uspořádání

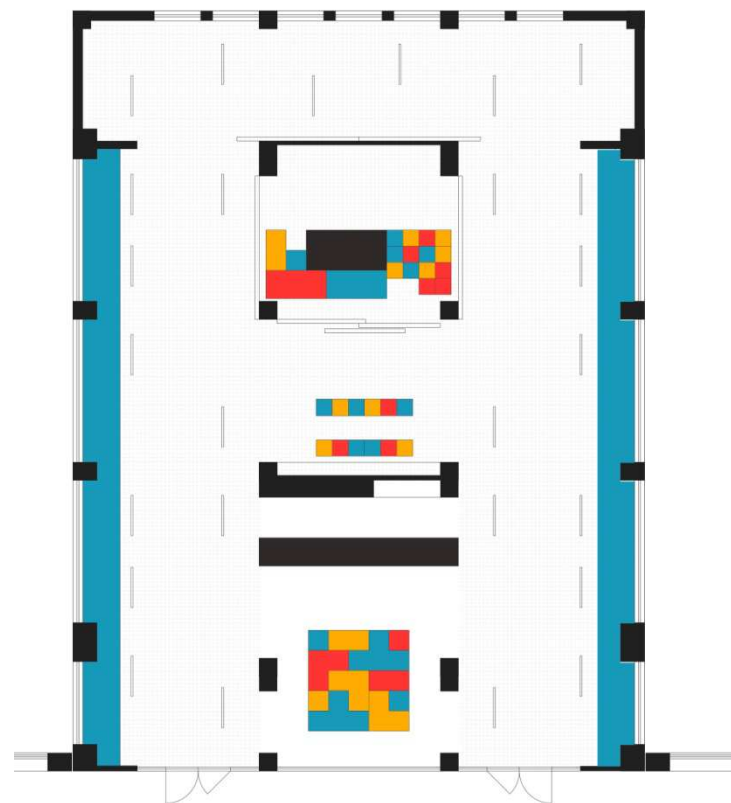
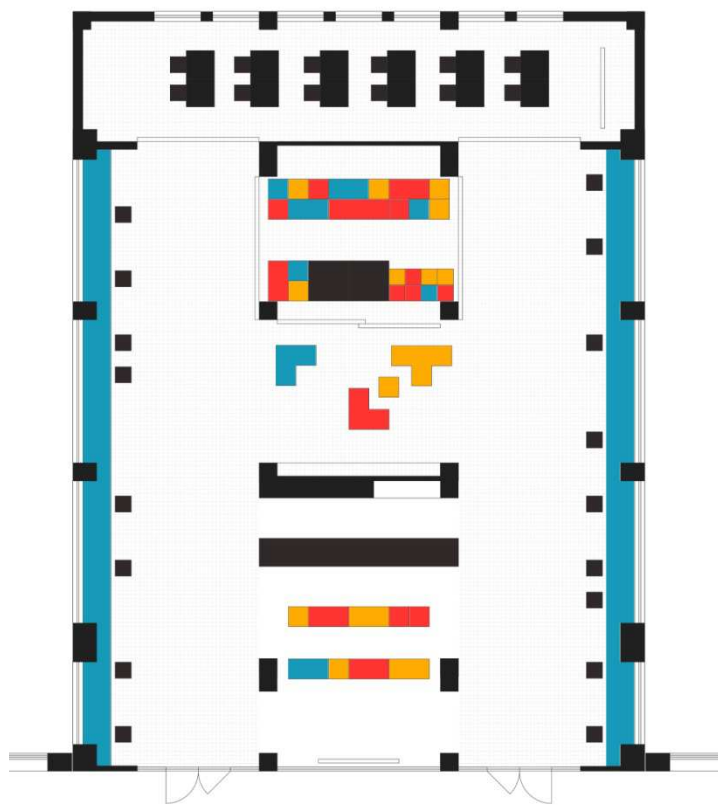

[púdorysy_projekce/školení/výstava/posterová konference](#)

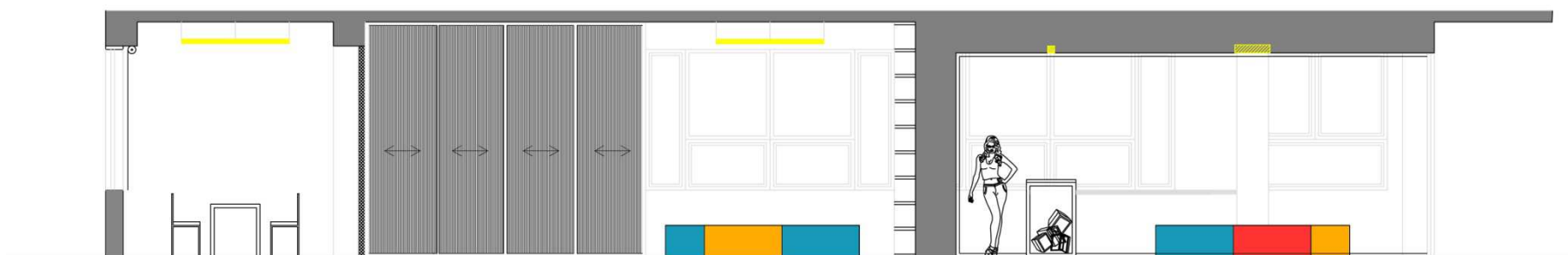

řezopohledy

1.

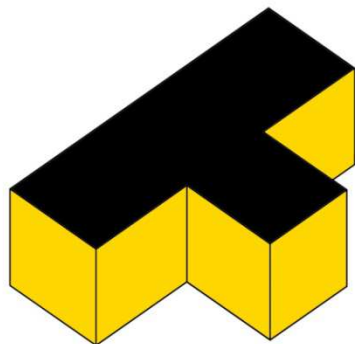

2.

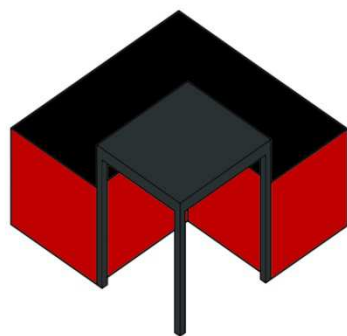

3.

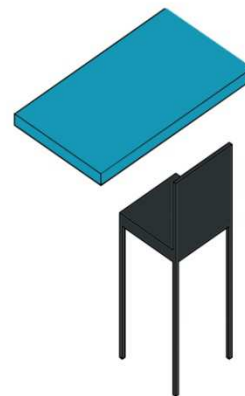

4.

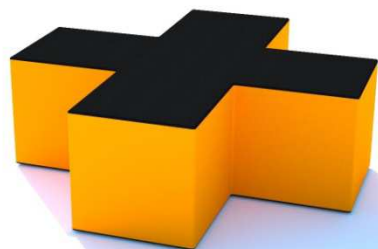
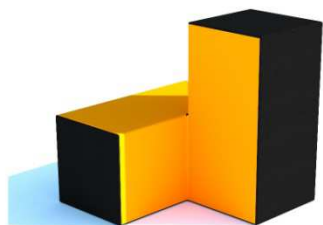
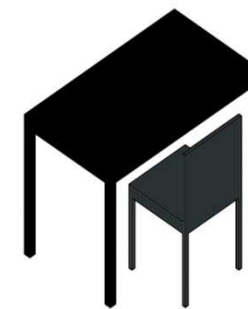

židle LIBERTY BAR



židle LIBERTY



přehled použitého nábytku
v závislosti na pracovních požadavcích

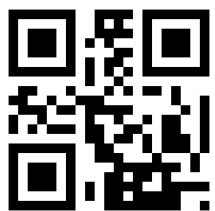
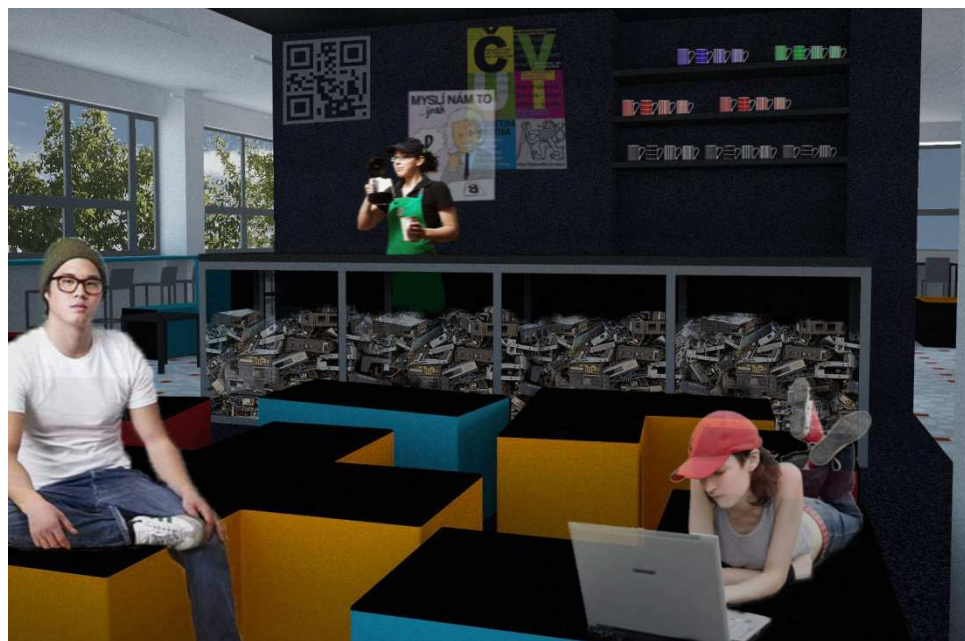
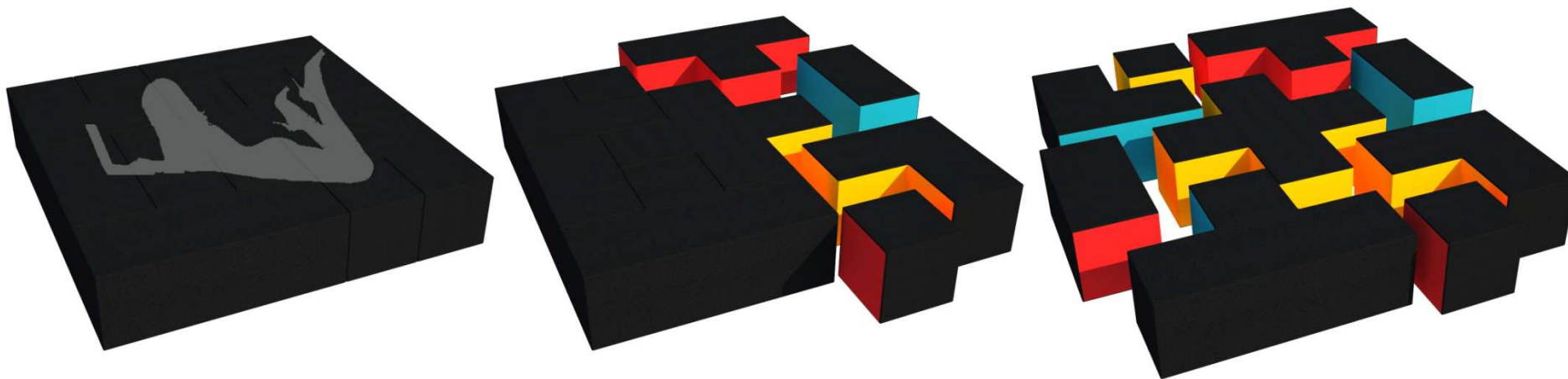

nábytek vyrobený na zakázku
základní rozměr 50x50x50 cm
libovolně seskupovatelný
lze složit do velkého letiště 2,5x2,5 m

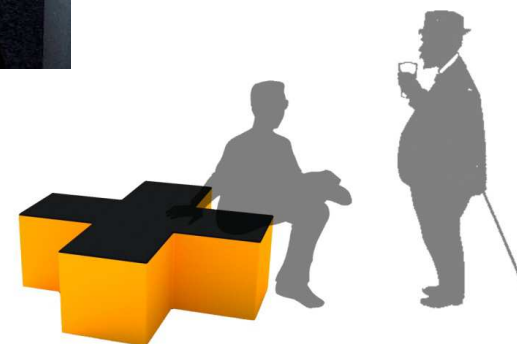

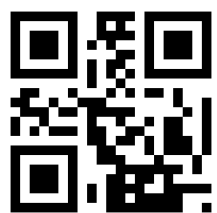
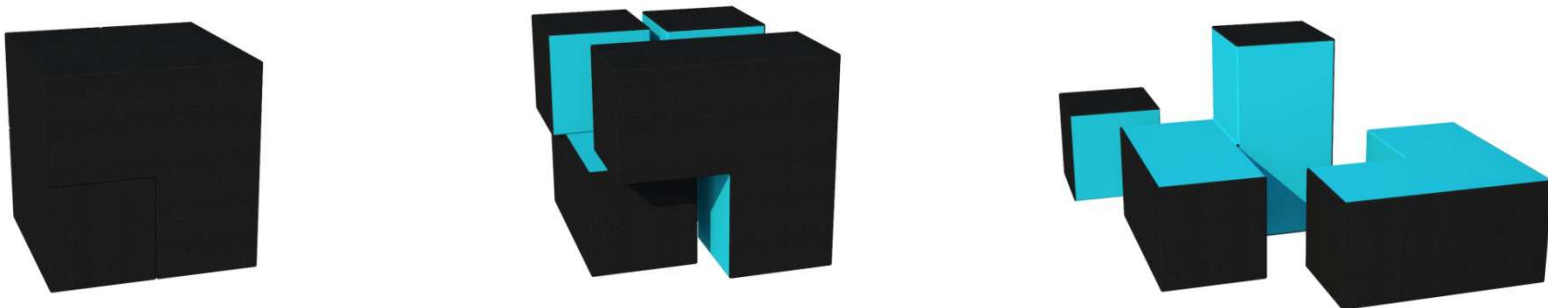

nábytek vyrobený na zakázku, doplněný stolky IKEA
základní rozměr 50x50x50 cm
libovolně seskupovatelný
lze složit do krychle o rozměrech 1x1x1 m

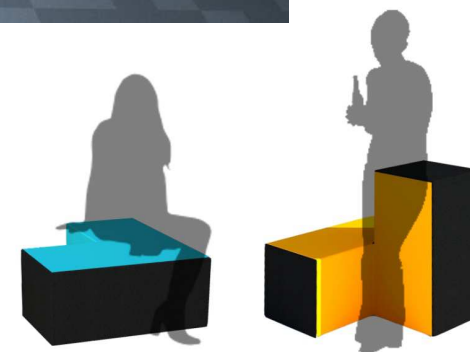

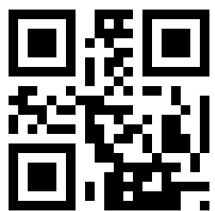

židle LIBERTY BAR, LIBERTY
pracovní pult po délce oken lemovaný pruhem zásuvek
čtvercové stoly v tiché studovně –
volně seskupovatelné dle potřeby

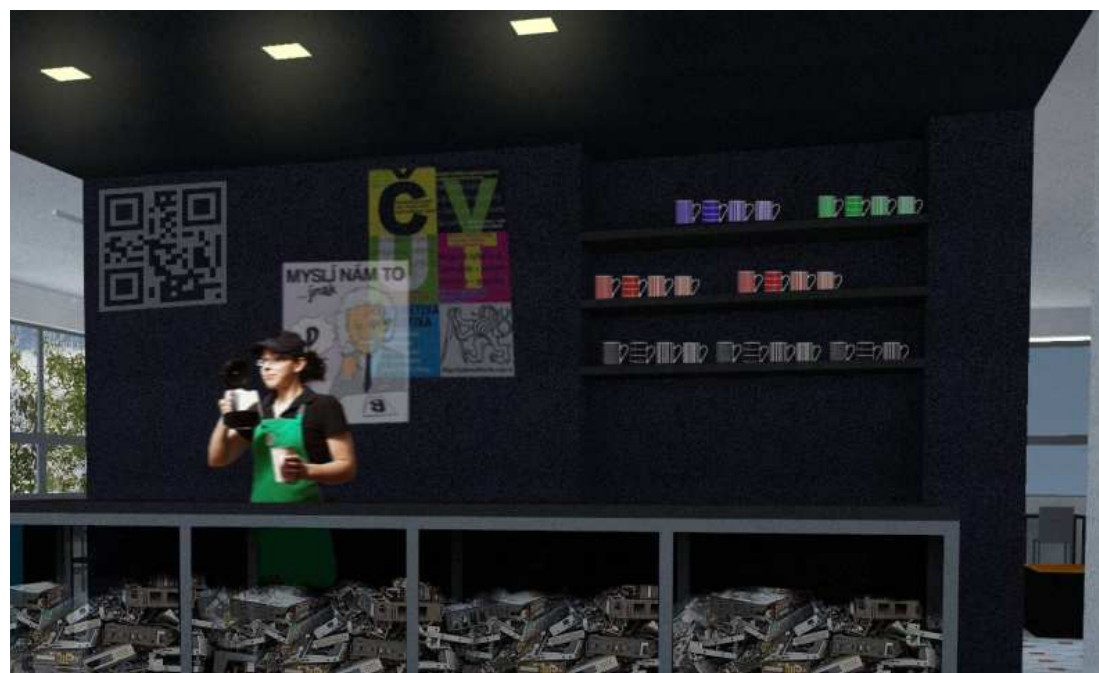
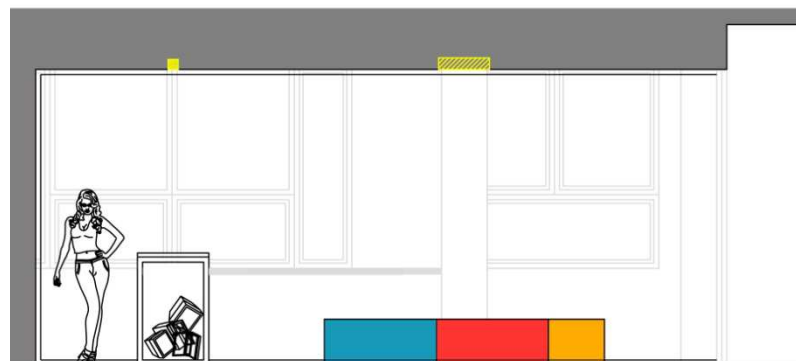
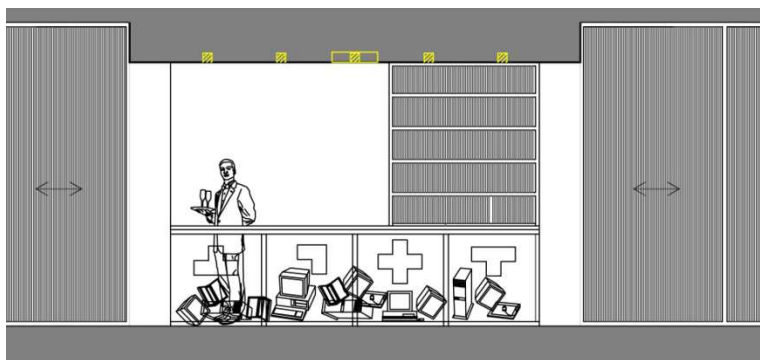

osvětlení_prostor baru-kavárny se sníženým pohledem
bodová světla zapuštěna do pohledu

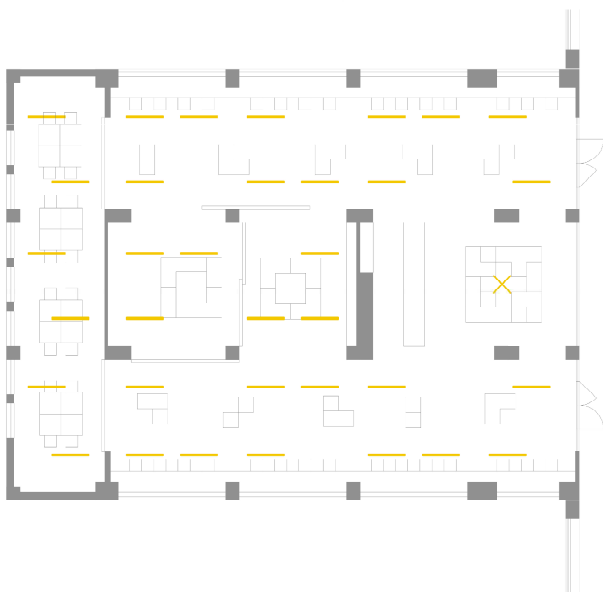

osvětlení_studijní a pracovní zóna
zářivky zavěšené jednoduchým systémem

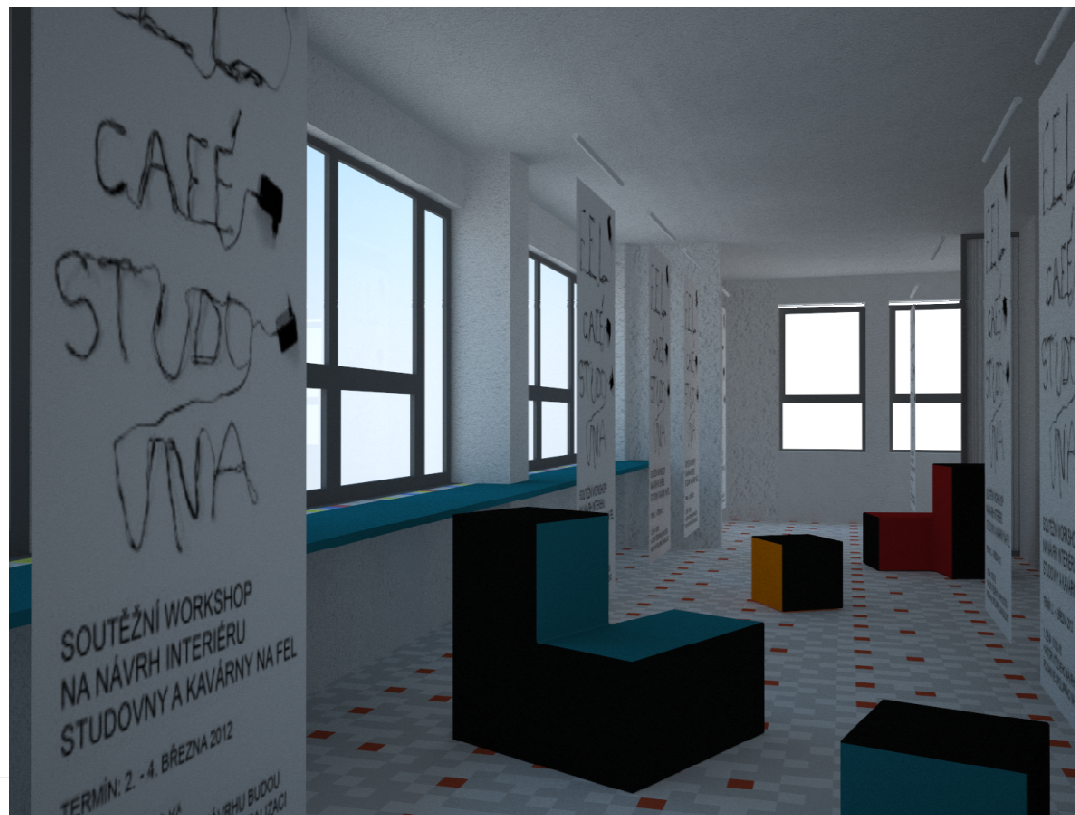
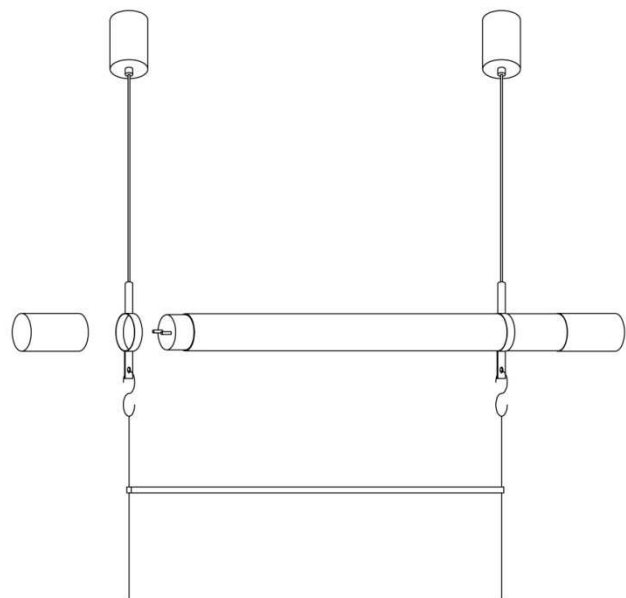

přípevnění posterů
jednoduchý systém věšení na osvětlení

BAR →



STUDENTI FEL ŠROTUJÍ!

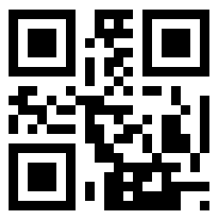

návrh baru
jednoduchá ocelová konstrukce opláštěná průsvitným plexisklem
uvnitř vysloužilá elektronika - šrot - recyklace

podlahová krytina_marmoleové dílce barevné

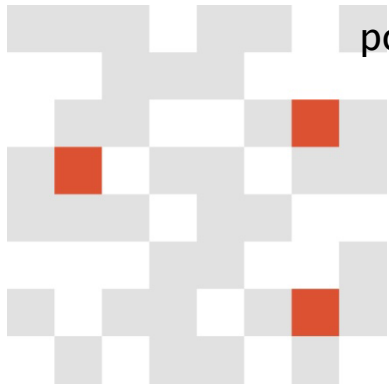

bílá výmalba

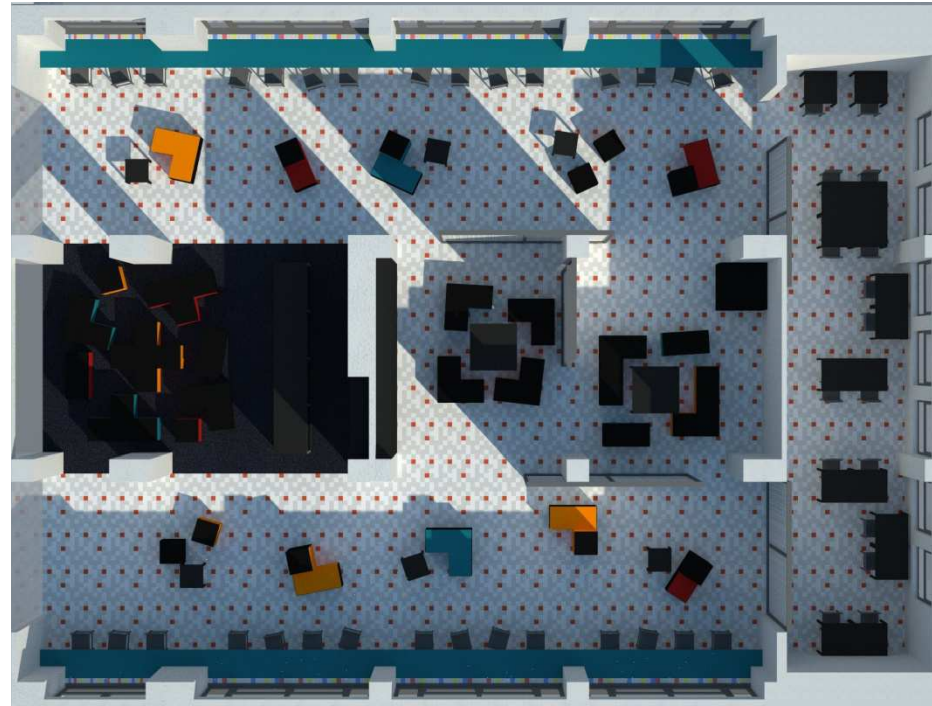

podlahová krytina_marmoleové dílce černé

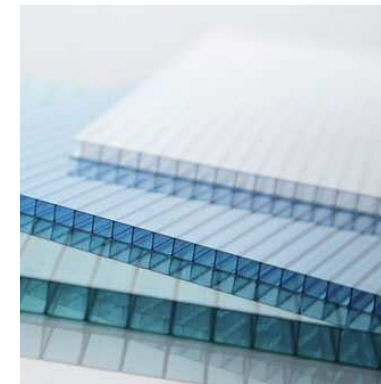

dělicí konstrukce_polykarbonát



vizualizace_materiálové řešení

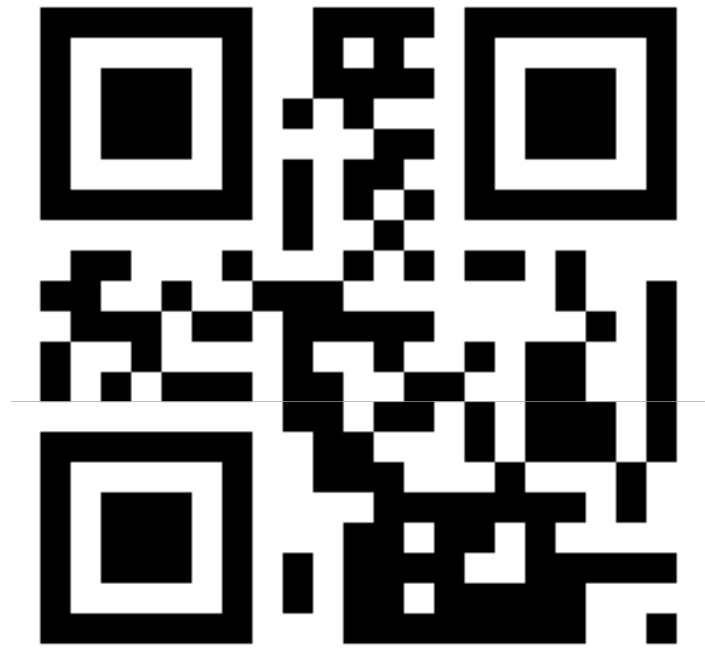

kuku ↓

